



A Crexendo® Company

ESI eCloud

eFax for eCloud User's Guide

Thank you for choosing ESI eFax for eCloud which is integrated into your eCloud eConsole. This document will guide you through the basics for sending faxes, receiving faxes and viewing fax history.

Contents

Introduction	2
ESI eFax for eCloud	2
Users	2
Fax Settings	2
Send a Fax	4
Receive a Fax	6
Sharing a Fax Service	9
Office Manager	12
Adding Fax Numbers	12
PC to Fax (Windows Only)	13
Fax to Fax ATA Network Diagram	17
Hooking up the ATA	17
ESI eFax for eCloud (Legacy Portal)	18
Account Login	18
Change your password	18
Account Settings	19
Personal Information	19
Fax Send and Receive Confirmation	20
Send a Fax	21
Email to Fax	21
Web to Fax	22
Fax Activity Report	23
FAQ	25
ESI eFax	25
ESI eFax via eConsole	26
Dialing and Sending Faxes	27
Receiving Faxes	27

Introduction

There are two types of ESI eFax for eCloud users, ESI eFax via eConsole which is integrated directly into your eConsole user login and ESI eFax which is a separate portal and windows application for faxing. Please see the table of contents for your specific ESI eFax service. You may determine your fax service by if you are using your ESI eConsole login for faxing, or not. If you are still unsure, please contact your office manager or support for assistance.

ESI eFax for eCloud

Users

ESI eFax via eConsole users can send and retrieve faxes from their eConsole. This section describes the procedures for individual users to set up their fax preferences, send and retrieve faxes.

Prerequisite: Users must be either assigned a fax number from the Office Manager or shared by the Primary user.

Fax Settings

These procedures are intended for the user for which the fax number has been created.

Navigate to the **Fax** Tab in the main Menu of the eConsole.

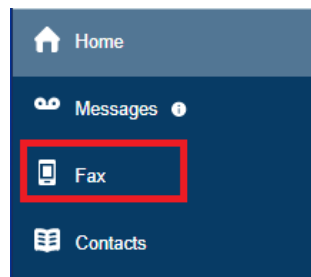

The fax panel will show a list of faxes that have been sent and received (initially the inbox will be empty):

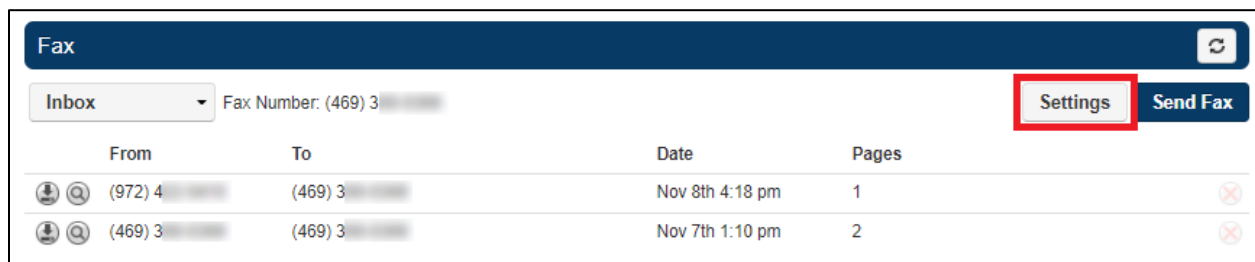

Note that faxes are stored for 90 days in eConsole.

Click on the **Settings** button to open the panel where the user can set individual preferences for managing faxes. The **Settings** modal includes similar options as the management interface but these are controlled by the user rather than the Office Manager.

Edit (214) [Close]

Primary User ⓘ 4000

Number Sharing ⓘ Disabled

Enabled Methods

- Email ⓘ
- ATA ⓘ

Inbound Fax Handling

- Email w/ Attachment ⓘ
- Email w/o Attachment ⓘ

Delivery Notifications

- Email ⓘ
- ATA ⓘ

Failure Notifications

- Email ⓘ
- ATA ⓘ

Cancel Save

1. **Number Sharing:** Select whether this number can be shared with other users, with an entire site or with everyone. Select disabled if this number should only be used by the Primary User. For more information, please refer to the section titled "[Sharing a fax service](#)" in this document.
2. **Enabled Methods:** These settings are informative for the user and cannot be changed.
3. **Inbound Fax Handling:** When a fax is received for this account, select whether the fax should be emailed with attachment or emailed without attachment. Additionally, select whether or not the fax should remain in the portal.
4. **Delivery Notifications:** Select whether to send an email notification when an outbound fax through the portal is successful and/or select whether to send an ATA (ie: Analog Telephone Adapter) notification to the fax machine when an outbound fax through the portal is successful.
5. **Failure Notifications:** Select whether to send an email notification when an outbound fax through the portal fails and/or select whether to send an ATA notification to the fax machine when an outbound fax through the portal fails. Click on the Save button to save your setting.

Send a Fax

eConsole

Click on the Send Fax button to open up the Send Fax panel.

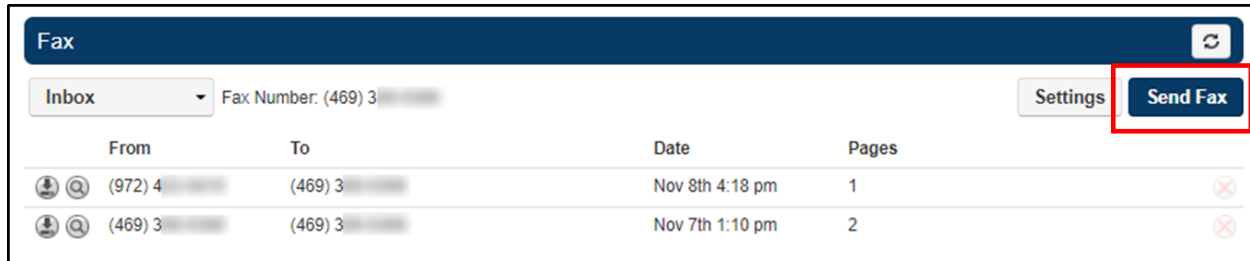

Select what you want to fax and optionally include a cover letter.

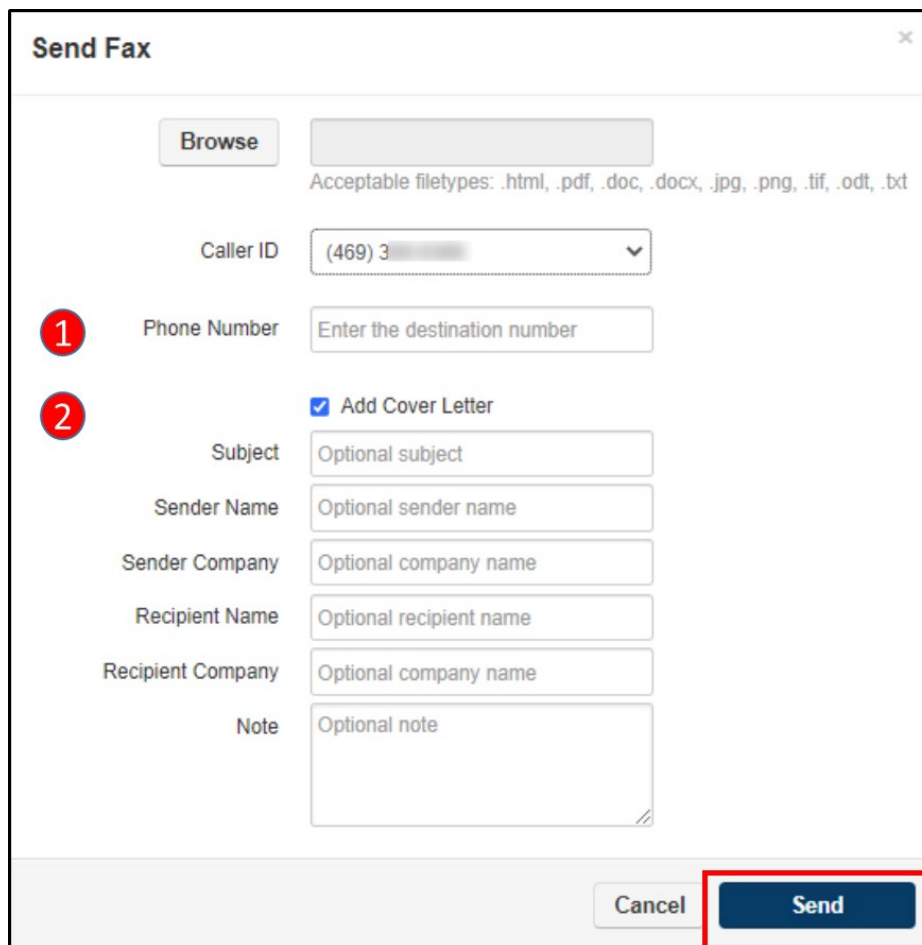

The screenshot shows the "Send Fax" panel. It has a title bar with "Send Fax" and a close icon. The panel contains several fields and a checkbox. A "Browse" button is next to a file input field. Below the file input field, it says "Acceptable filetypes: .html, .pdf, .doc, .docx, .jpg, .png, .tif, .odt, .txt". There is a "Caller ID" dropdown menu with "(469) 3...". A red circle with the number "1" is next to the "Phone Number" field, which has the placeholder text "Enter the destination number". A red circle with the number "2" is next to the "Add Cover Letter" checkbox, which is checked. Below the checkbox are several text input fields for "Subject", "Sender Name", "Sender Company", "Recipient Name", and "Recipient Company", all with placeholder text. At the bottom, there is a "Note" field with the placeholder text "Optional note". At the bottom right, there are "Cancel" and "Send" buttons. The "Send" button is highlighted with a red box.

Select the file you want to fax using the Browse button (Acceptable file types are listed under the file field).

1. **Phone Number:** Enter the phone number of the fax recipient.
2. **Add Cover Letter:** Check mark this option if you want to add a cover letter to your fax. Fill out the cover letter fields and click on the Send button to send your fax.

Email to Fax

Fax documents may be sent from your email account assigned to your ESI eFax for eCloud service to your fax destination phone number. Email to Fax supports the most popular file types and up to 3 documents on a single email. If you plan to share your eFax service with multiple employees, it is recommend to create a separate email account that is exclusively used for faxing. Please contact ESI support if you are unsure of which email account to use.

From your email account.

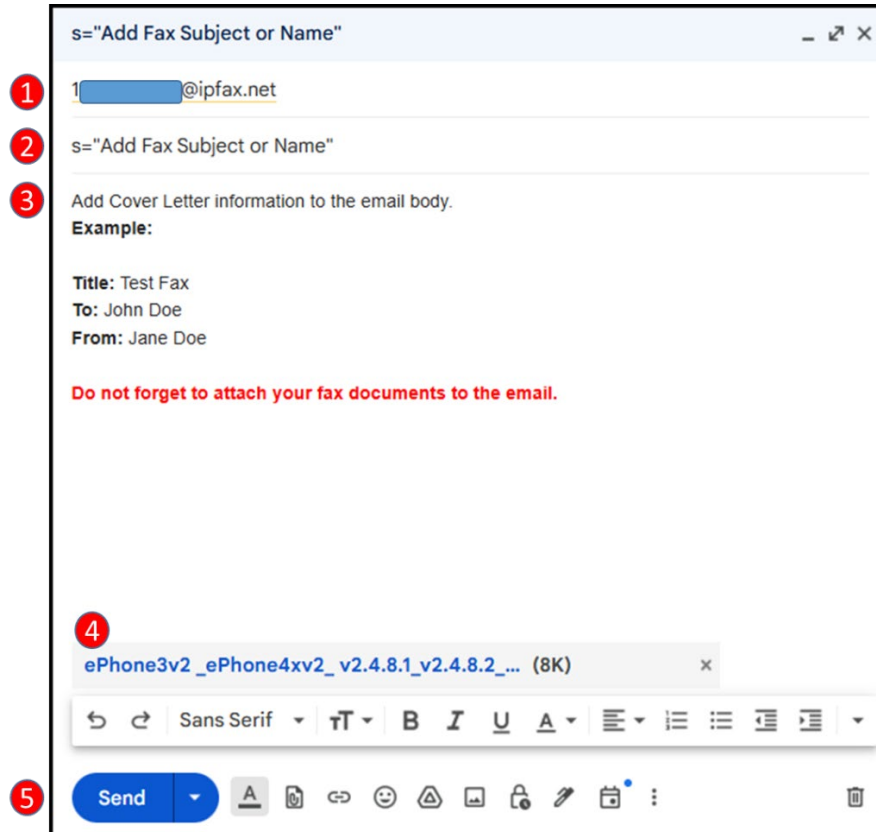

1. In the To field, enter the fax number of the destination of the fax as follows: 12145551234@ipfax.net. The destination number must begin with 1 or destination country code.
2. In the subject field, enter s= and the fax subject. **Example:** s=Test Fax
3. In the body of the email, enter any text you want to appear on the cover letter.
4. Attach the desired file to be faxed.
5. Press Send.

Fax to Fax (ATA)

Customers with Fax to Fax ATA's may go to the fax machine to send faxes out as normal. See Fax to Fax ATA Network Diagram for network and fax machine connections.

Receive a Fax

eConsole

Depending on your selection in the **Inbound Fax Handling** field in the **Fax Settings**, you could receive an email notification with the attached fax file, a simple email notification without an attachment or the fax will show up in your fax inbox in eConsole. The following steps describe how to retrieve a fax in the eConsole.

The inbox in your fax section of the eConsole will show faxes have been received.

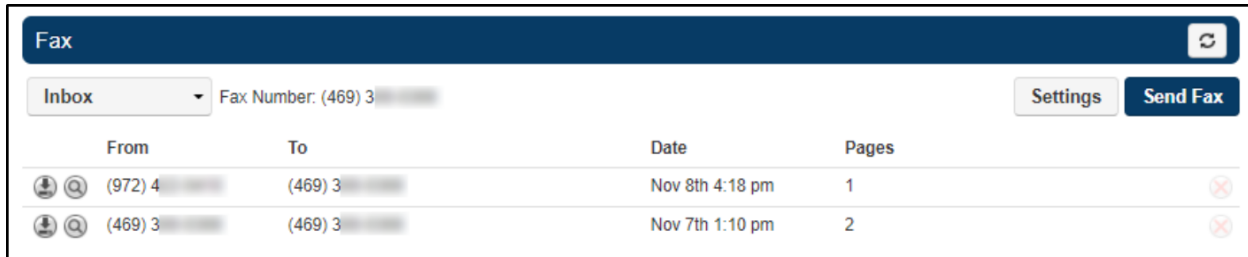

From	To	Date	Pages
(972) 4 [redacted]	(469) 3 [redacted]	Nov 8th 4:18 pm	1
(469) 3 [redacted]	(469) 3 [redacted]	Nov 7th 1:10 pm	2

The magnifying glass icon gives you an opportunity to have a sneak peek of the first page of the received fax. Just hover your mouse pointer over that icon to get the preview.

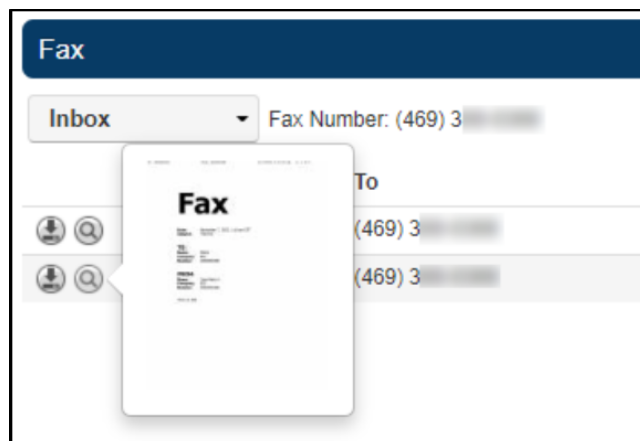

To retrieve the received fax, Click on the Download icon.

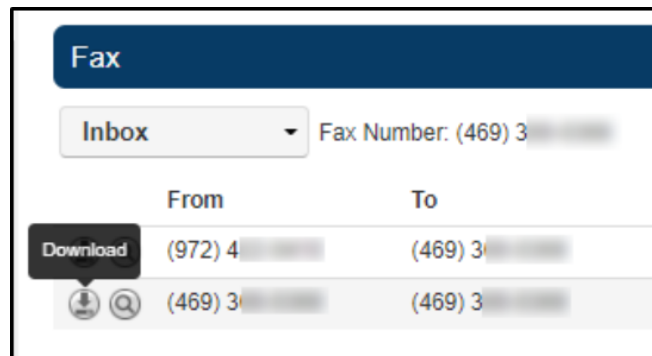

Check the bottom left corner of your browser and click on the downloaded file to see its contents.

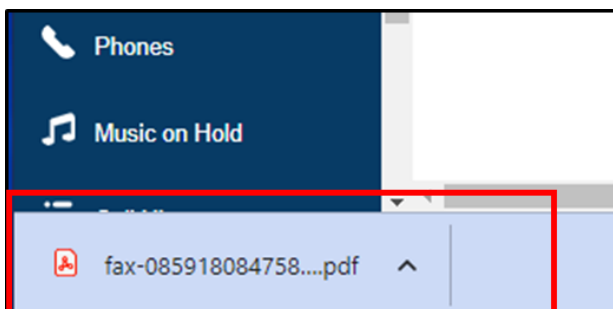

Once you have the actual .pdf file of the fax, you can save it to your own computer and proceed to delete the fax from your inbox. Simply click on the delete icon that looks like an X  to the right of the fax to delete it from your inbox.

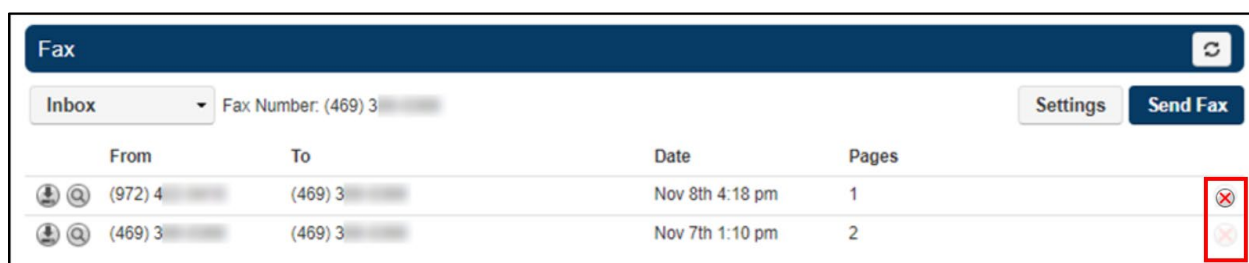

We recommend saving your faxes to your own computer and keeping your inbox with a minimum number of faxes in it as there is a limited amount of storage (set for your account and which is shared with voicemails received). This will also eliminate the risk of accidentally deleting a fax from the inbox and permanently losing its contents.

You can also see the contents of faxes already sent. This will give you the opportunity to verify that the intended content was included in any given fax. To do that, simply click on the dropdown menu for the inbox and switch to the Sent option.



The procedures are similar to those used in the Inbox. To get a preview of a sent fax, simply hover the mouse over the magnifying glass icon.

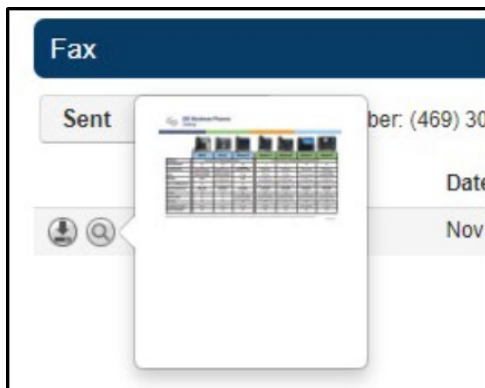

To retrieve the sent fax, click on the Download button.

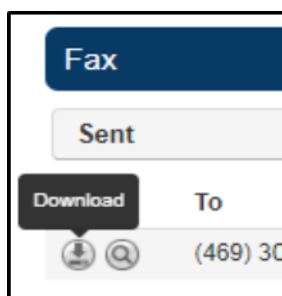

Check the bottom left corner of your browser and click on the downloaded file to see its contents.

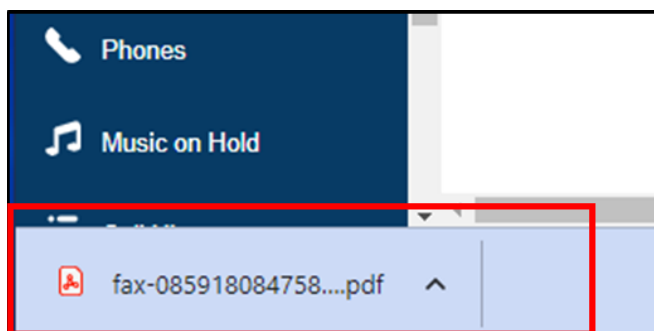

We recommend cleaning up the Sent faxes area to keep sufficient storage space for future faxes.

Fax to Fax (ATA)

Sites with Fax to Fax ATA's may receive faxes at the following locations.

1. At the fax machine.
2. Email sent to the designated email address with a PDF attachment of the fax.
3. Both, at the fax machine and via email.

ATA must be purchased from ESI as it is preloaded with custom firmware.

Sharing a Fax Service

Sharing the fax service may be useful in some business environments. There are some considerations that need to be taken into account when sharing the fax service with other users.

There are two options to share the fax service:

1. Service shared by the service owner
2. Dedicated Fax extension accessed by multiple users

These options are explained in the following sections.

Option 1 – Service shared by the service owner

- a) A user owning the fax service can share it with other individual users, all users in a site or all users in a domain. Sharing fax service means that other users will be able to send faxes using the fax number of the person sharing the service with them. These users will not be able to change the settings of the fax service though. The top portion of the fax panel of the user sharing the service will look something like this:



Fax			
Inbox	Fax Number: (469) 3...	Settings	Send Fax
From	To	Date	Pages

While the top portion of the same panel of the user with whom the service is being shared, will look like this:



Fax		
Sent	Fax Number: (469) 3... Shared	Send Fax
To	Date	Pages

- b) Incoming faxes and their corresponding notifications will be received by the owner of the fax service. If other users have given the fax number of the service owner to someone else to receive faxes, then the owner of the service will have to download the fax himself and forward it via email to the appropriate recipient.

The following figures illustrate this option.

SENDING FAXES

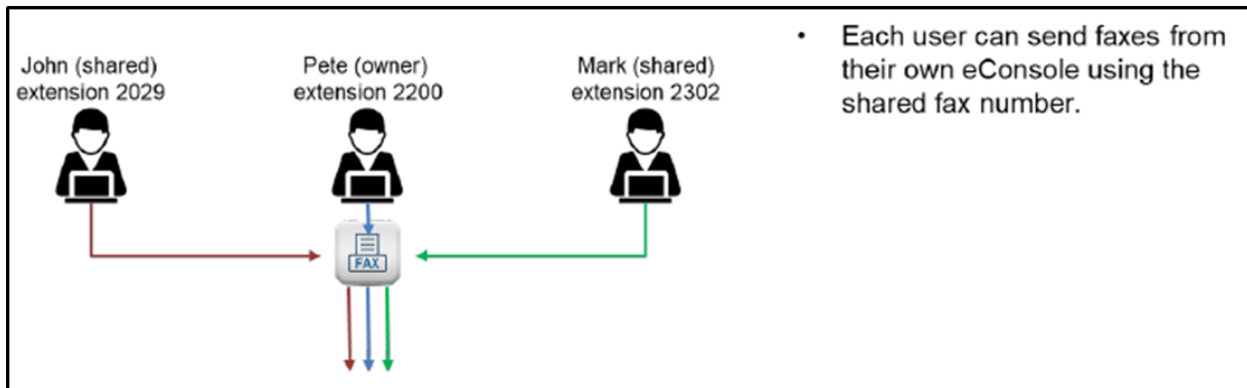

- Each user can send faxes from their own eConsole using the shared fax number.

RECEIVING FAXES

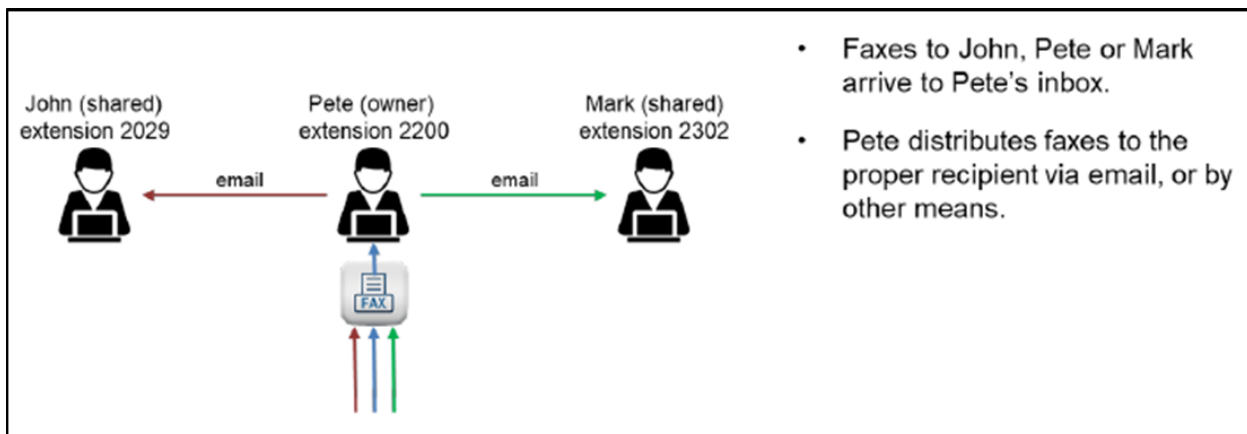

- Faxes to multiple people arrive in one person's inbox. That person distributes the faxes to the proper recipient via email or by other means.

Option 2 – Dedicated fax extension accessed by multiple users

In this option, an extension number is set up exclusively for fax service. There are no other features associated with this extension. The credentials for that fax extension can then be shared with users who need to send/receive faxes. Each user will then need to log in to that extension's eConsole and send/receive faxes from there. The following figures illustrate this option.

SENDING FAXES

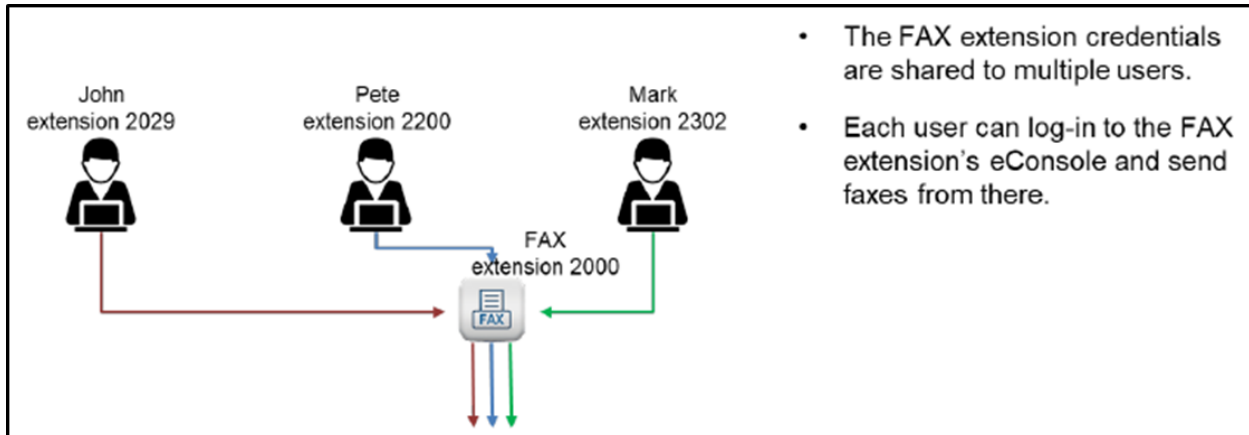

- The FAX extension credentials are shared to multiple users. Each user can log in to the FAX extension's eConsole and send faxes from there.

RECEIVING FAXES

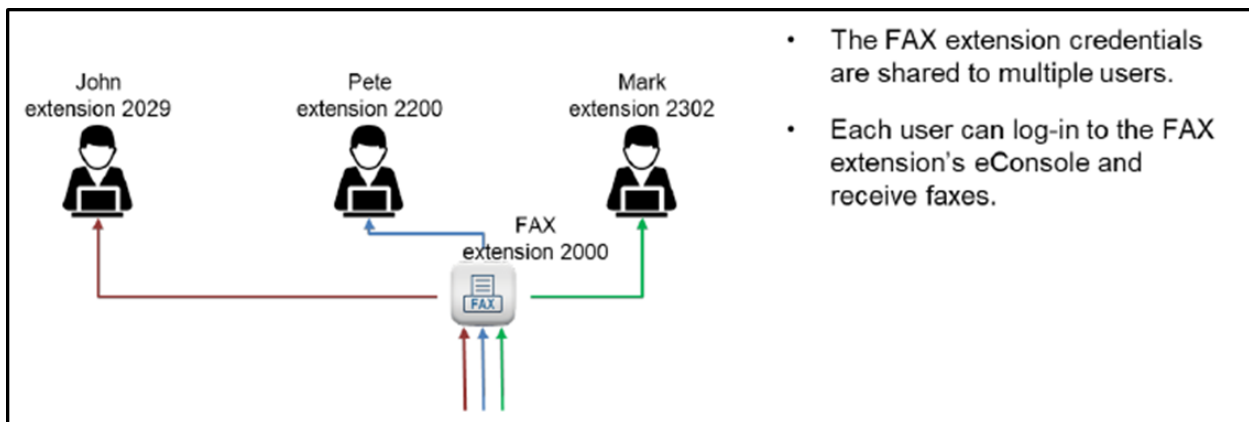

- The FAX extension credentials are shared to multiple users. Each user can log in to the FAX extension's eConsole and receive faxes.

Privacy needs to be considered in both options as more than one person can see other people's faxes. Option 2 gives the possibility for each user to delete their own faxes, but that needs to be managed by the enterprise.

Office Manager

Adding Fax Numbers

This is an Office Manager's procedure and the eConsole User must be logged in as an Office Manager. Navigate to **Inventory** in the main menu, and then select **Fax Accounts**. Click on the **Add Fax Number** button.

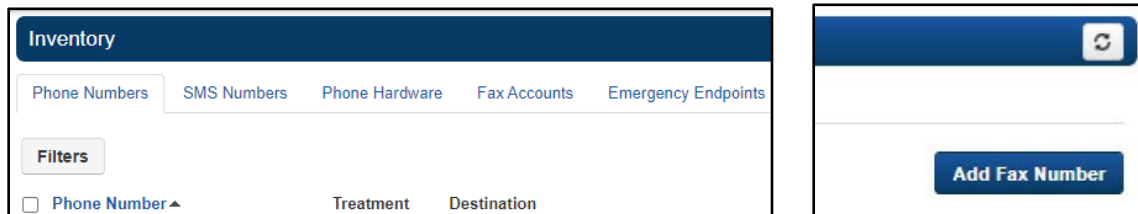

When the **Add a Fax Number** modal is presented, select an available number. These numbers are pulled from the domain's inventory. Only DID (ie: Direct Inward Dial) numbers that have the treatment set as **Fax Server** or **Available DID** will show in the dropdown. When adding as a new fax number, only select an available DID.

The image shows the 'Add a Fax Number' modal form with the following fields and options:

- 1. Phone Number: A dropdown menu with '1' selected.
- 2. Primary User: A text input field containing '1001 (Basic User 1)'. A red circle highlights this field.
- 3. Number Sharing: A dropdown menu with 'Disabled' selected.
- 4. Enabled Methods: A section with a green border and a red box around it. It contains two checkboxes: 'Email' (unchecked) and 'ATA' (checked). A red text label 'Only Select 1' is positioned to the right of the 'ATA' checkbox.
- 5. Inbound Fax Handling: A section with three checkboxes: 'Email w/ Attachment' (checked), 'Email w/o Attachment' (unchecked), and 'ATA' (checked).
- MAC Address: A text input field containing '001fc123d489'.
- 6. Delivery Notifications: A section with two checkboxes: 'Email' (checked) and 'ATA' (unchecked).
- 7. Failure Notifications: A section with two checkboxes: 'Email' (checked) and 'ATA' (unchecked).

At the bottom of the modal are 'Cancel' and 'Add' buttons.

Finish selecting the following options in the Add a Fax Number modal. Click Add when finished.

1. **Phone Number:** Select an available number.
2. **Primary User:** Who will own this fax account number? This user will have faxes available in their portal and allow them to manage inbound settings for this account.
3. **Number Sharing:** Select whether this number can be shared with other users or with everyone. Select disabled if this number should only be used by the Primary User. For more information, please refer to the section titled "Sharing a fax service" in this document.

4. **Enabled Methods:** Select the applicable handling methods for this DID. If using an ATA (ie: Analog Telephone Adapter), then a serial number must be entered.
 - a. **NOTE: Only select 1.** If both are selected, the fax will **NOT** be sent to the ATA as the settings are a hierarchy and Email is priority 1. ATA has its own email options if the user wants email copies of the faxes.
5. **Inbound Fax Handling:** When a fax is received for this account, select whether the fax should be emailed with attachment or emailed without attachment. Additionally, select whether or not the fax should remain in the portal.
6. **Delivery Notifications:** Select whether to send an email notification when an outbound fax through the portal is successful and/or select whether to send an ATA notification to the fax machine when an outbound fax through the portal is successful.
7. **Failure Notifications:** Select whether to send an email notification when an outbound fax through the portal fails and/or select whether to send an ATA notification to the fax machine when an outbound fax through the portal fails. Then Click on the Add button.

The account will now be created on the server. The DID number will also be updated in the DID table to "Fax Server" treatment.

PC to Fax (Windows Only)

You can also send a fax directly from your PC (ie: Personal Computer).

If you have not installed the software, visit [ESI Resource Library](#) to download the PC to Fax software zip file. Then unzip and run the setup.exe file to install the software.

Once the software is installed, first time users will need to enter their account information to login. If you do not know your account login information, please see [Change Password](#).

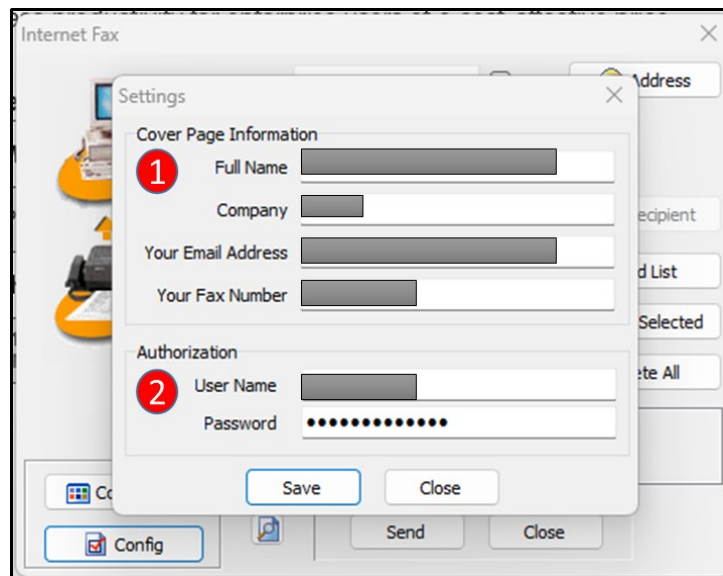

1. **Cover Page Information:** Enter your information as it would appear on the fax cover page.
2. **Authorization:** Enter your Username and Password. If you do not know your account login information, see the Account Login section for recovery procedures.

Send a Fax

From the document application you have created your content in go to the **File Menu** and select **Print**.

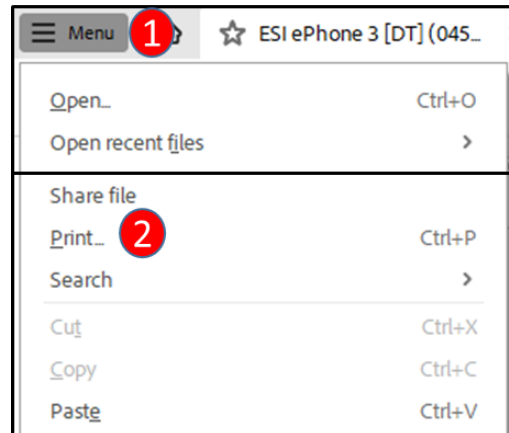

Select the Internet Fax from the list of printers from the Printer drop down menu, and then select Print.

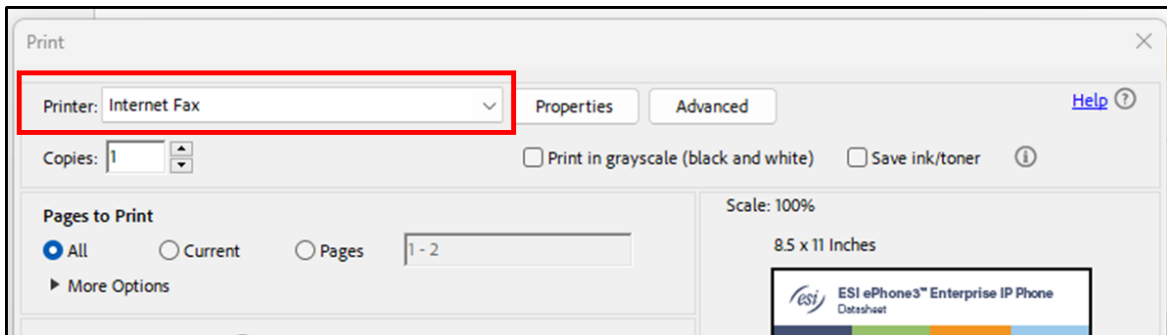

Complete faxing information:

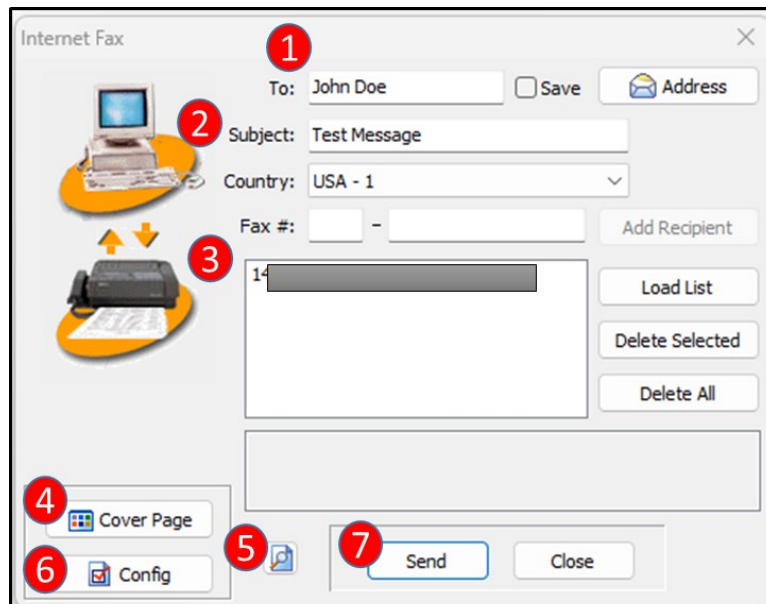

1. **To:** Enter recipient's name.
2. **Subject:** Enter fax subject.

3. **Fax #:** Enter the desired fax number, then click **Add Recipient**
 - a. Up to 10 destinations may be added.
4. **Cover Page:** Set cover page options.
5. **Preview Icon:** See a preview of the fax to be sent
6. **Config:** ESI eFax Account Information and Password login settings.
7. Click **Send** to send the fax.

Cover Page Options

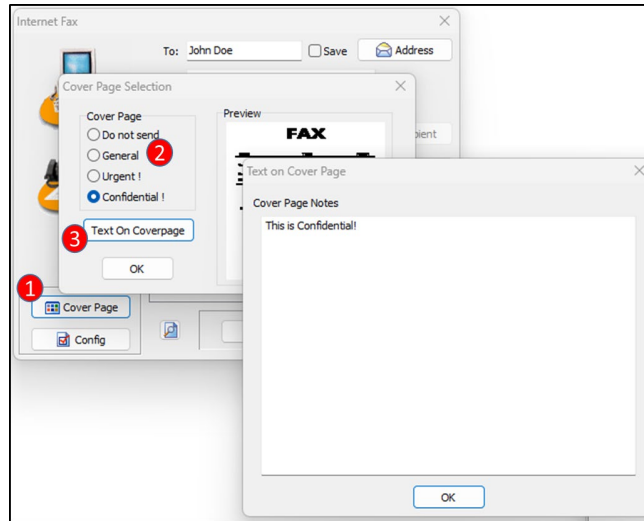

1. Select **Cover Page**
2. Select **Cover Page** priority
3. Add additional text to the cover page.

Realtime Notifications

After sending your fax, realtime notifications will keep you up to date on whether your faxes were sent successfully or not.

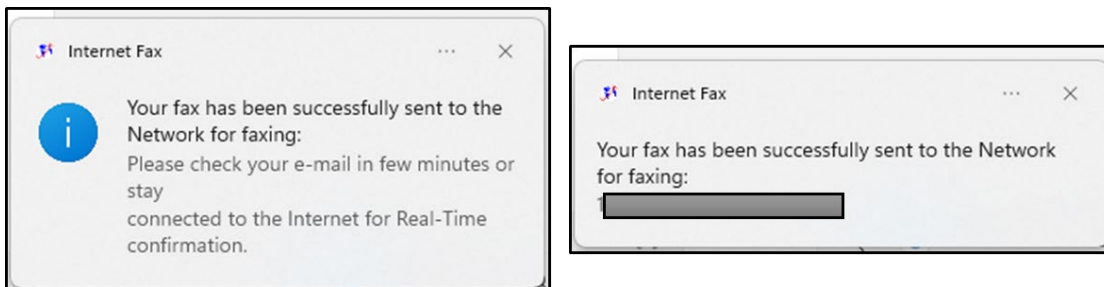

Secure Fax File Cabinet

The **Secure Fax File Cabinet** allows you to see sent fax status details, resend faxes, delete faxes from your file cabinet, save fax history as an .xls file, view sent fax pages and cover letter, and user settings.

To open **Secure Fax File Cabinet**, in your System Tray click the Secure Fax File Cabinet icon.

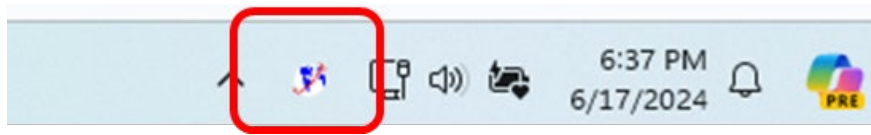

Secure Fax File Cabinet

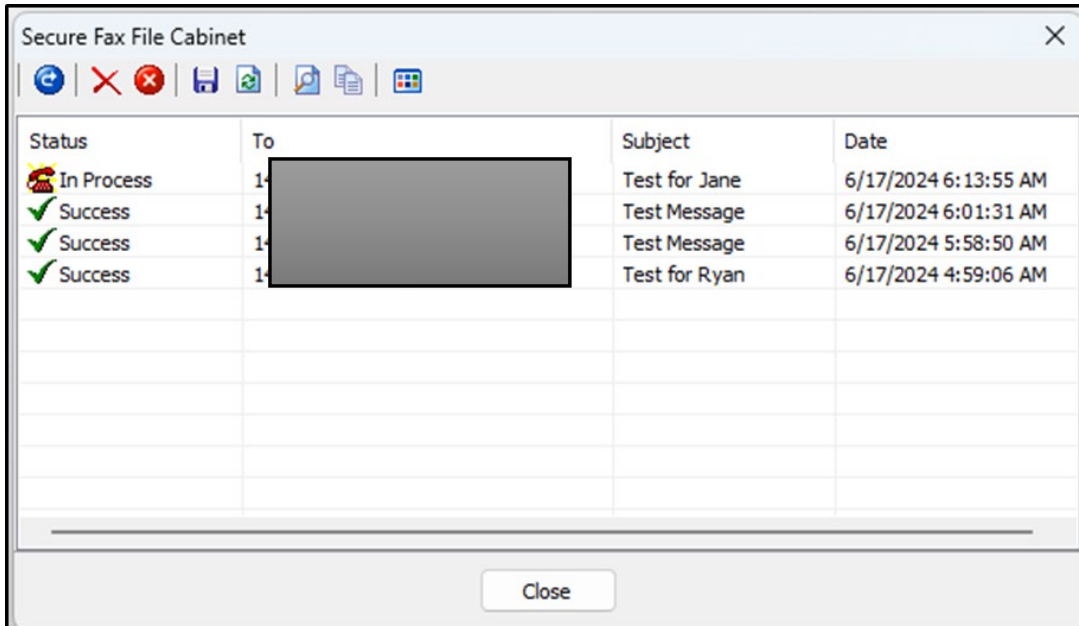

Fax to Fax ATA Network Diagram

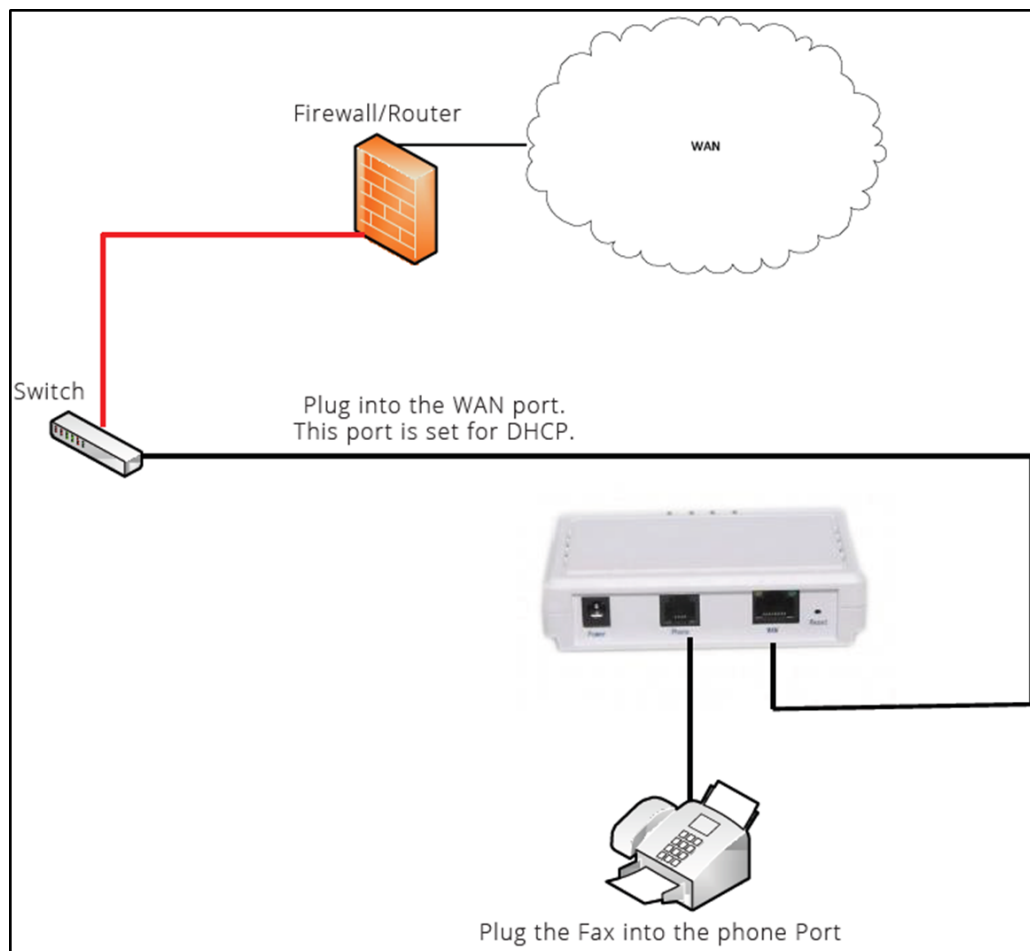

Hooking up the ATA

1. Connect the Ethernet Connector labeled "WAN" to your network.
2. Connect the port labeled FAX to the Fax Machine.
3. Connect the power supply to the FAX ATA (ie: Analog Telephone Adapter) and then to a wall power outlet. There is no ON/OFF (I/O) switch so the Fax ATA turns on as soon as you connect the power.
 - The POWER LED will light green.
 - When initialization completes in about one minute the STATUS LED and WAN LED will light green.

ESI eFax for eCloud (Legacy Portal)

Account Login

Access your user account by going to <https://secure.ipfax.net/>, and then enter your Username and Password. We recommend adding a Bookmark to your browser for quick access. Your initial login credentials will be given to you by ESI. We recommend changing it after you log in. You can also select **Forgot Password?** to receive a temporary password. If you have forgotten your **Username**, please contact ESI support for assistance.

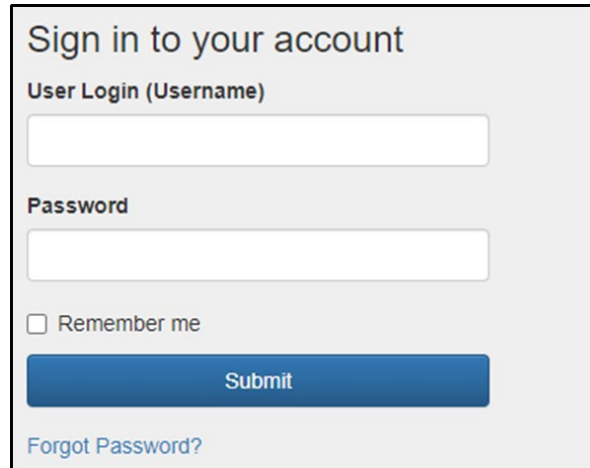

The screenshot shows a login form titled "Sign in to your account". It contains the following elements:

- A label "User Login (Username)" above a text input field.
- A label "Password" above a text input field.
- A checkbox labeled "Remember me".
- A blue "Submit" button.
- A blue link labeled "Forgot Password?" below the button.

Change your password

To change your password select **Change my password**, then enter your new password and click **Save**.

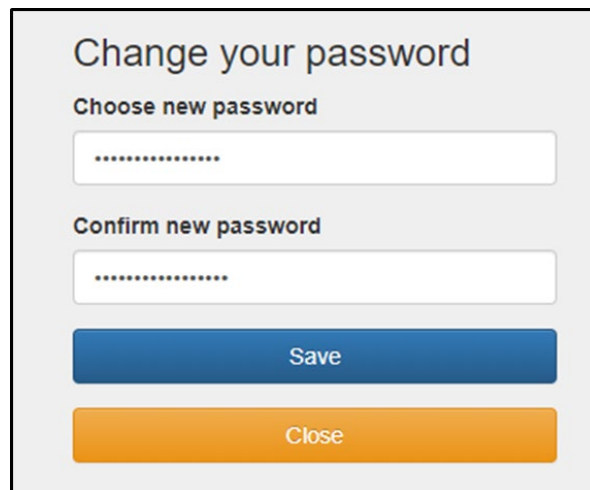

The screenshot shows a form titled "Change your password". It contains the following elements:

- A label "Choose new password" above a text input field with masked characters (dots).
- A label "Confirm new password" above a text input field with masked characters (dots).
- A blue "Save" button.
- An orange "Close" button.

Account Settings

Go to **My Account Info** to change your personal information, and fax delivery and receive confirmation settings.

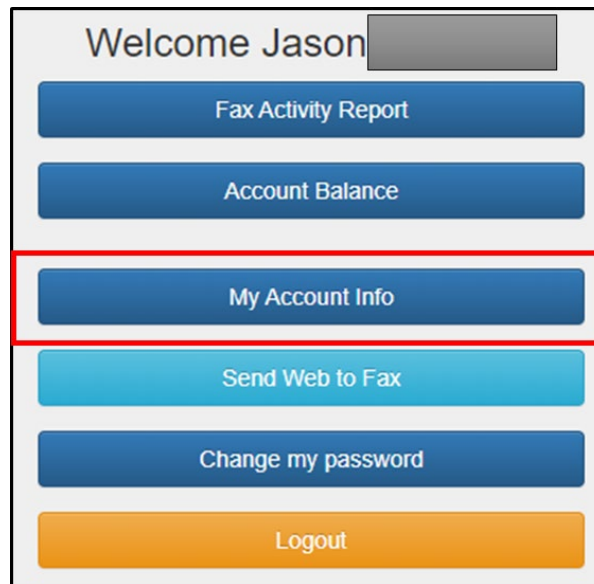

Welcome Jason [redacted]

- Fax Activity Report
- Account Balance
- My Account Info**
- Send Web to Fax
- Change my password
- Logout

Personal Information

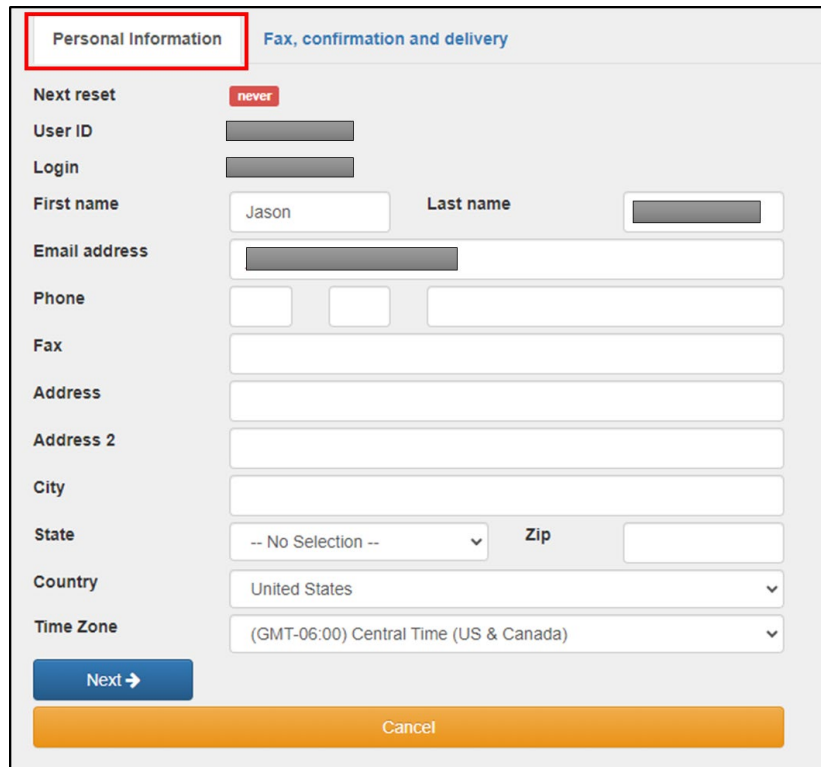

Personal Information Fax, confirmation and delivery

Next reset **never**

User ID [redacted]

Login [redacted]

First name Jason Last name [redacted]

Email address [redacted]

Phone [redacted]

Fax [redacted]

Address [redacted]

Address 2 [redacted]

City [redacted]

State -- No Selection -- Zip [redacted]

Country United States

Time Zone (GMT-06:00) Central Time (US & Canada)

Next →

Cancel

Enter all relevant information into the fields provided.

Fax Send and Receive Confirmation

Personal Information Fax, confirmation and delivery

Fax to Email No. [Redacted]

1 Fax to Email - Email [Redacted]

Send Fax to Email as PDF file

Fax to Fax No. [Redacted]

2 Fax to Fax - Email [Redacted]

Queue Fax When ATA is Offline

Deliver Incoming Fax to Fax Machine

Deliver Incoming Fax to Email

Deliver Incoming Fax to Fax Machine and Email

3 Fax Confirmation On Failure Success

4 Confirmation Email [Redacted]

5 Email Confirmation On Failure Success

Text

Text and First page

Text and All pages

← Previous Save Cancel

1. **Fax to Email - Email:** Enter the email destination for incoming Fax to Email faxes. Multiple email destinations may be separated with a comma.
2. **Fax to Fax - Email:** Enter your email address that Fax to Fax is to be sent to.
 - a. **Queue Fax When ATA is Offline:** Customers with ATA (ie: Analog Telephone Adapter) for fax machines may have incoming faxes Queue for seven days while offline. After 7 days faxes will be deleted and cannot be recovered.
 - b. **Delivery Options:** Select to have faxes delivered to only the fax machine, email, or both.
3. **Fax Confirmation On:** Select to receive confirmation for failed and successful Fax to Fax faxes.
4. **Confirmation Email:** Enter email address to send confirmations.
5. **Email Confirmation On:** Select to receive confirmation for failed and successful Fax to Email faxes. You can also select to receive the first page or all pages of the fax.

Send a Fax

Email to Fax

Fax documents may be sent from your email account assigned to your ESI eFax for eCloud service to your fax destination phone number. Email to Fax supports the most popular file types and up to 3 documents on a single email. If you plan to share your eFax service with multiple employees, it is recommend to create a separate email account that is exclusively used for faxing. Please contact ESI support if you are unsure of which email account to use.

From your email account.

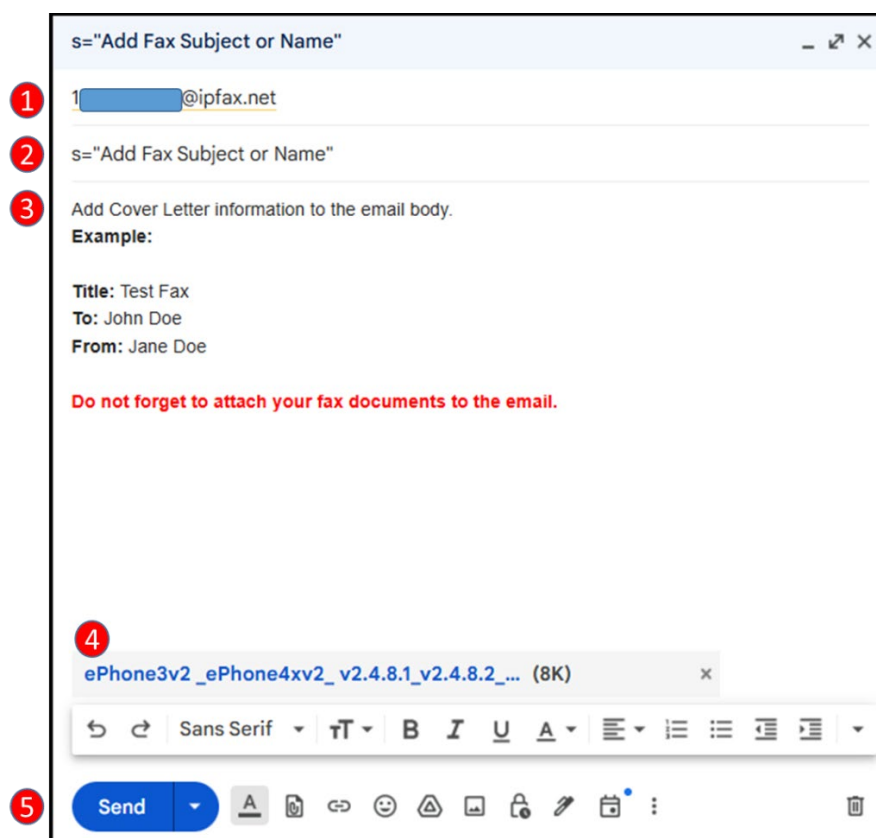

6. In the To field, enter the fax number of the destination of the fax as follows: 12145551234@ipfax.net The destination number must begin with 1 or destination country code.
7. In the subject field, enter s= and the fax subject. **Example:** s=Test Fax
8. In the body of the email, enter any text you want to appear on the cover letter.
9. Attach the desired file to be faxed.
10. Press Send.

Web to Fax

From the main menu select the **Send Web to Fax**  option.

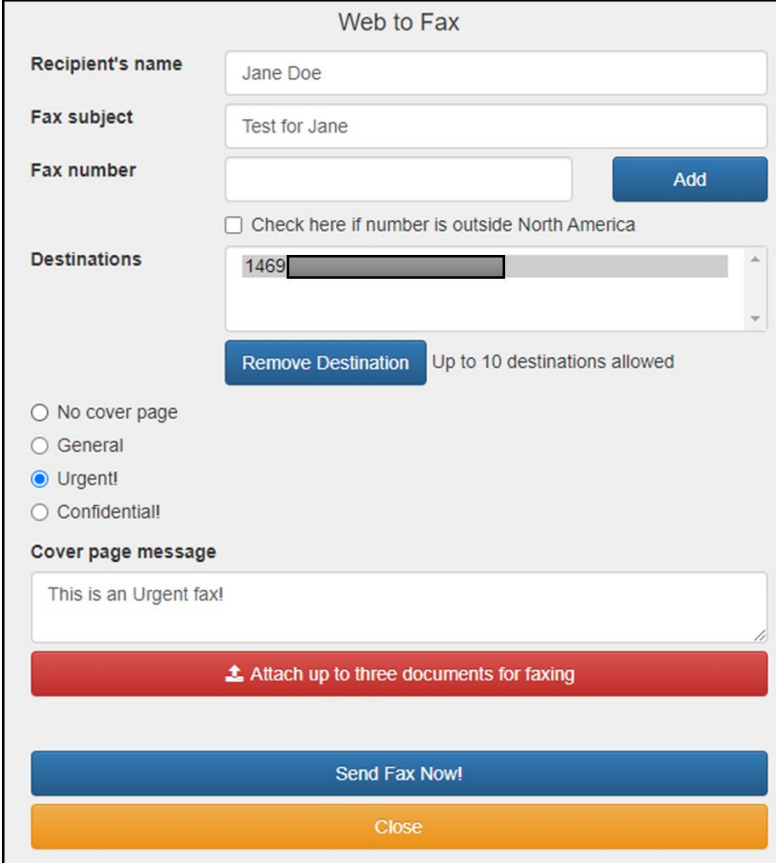

The screenshot shows a 'Web to Fax' form with the following fields and controls:

- 1** Recipient's name: Text input field containing 'Jane Doe'.
- 2** Fax subject: Text input field containing 'Test for Jane'.
- 3** Fax number: Text input field (empty) and an 'Add' button. Below it is a checkbox labeled 'Check here if number is outside North America'.
- Destinations**: A list box containing '1469'. Below it is a 'Remove Destination' button and the text 'Up to 10 destinations allowed'.
- 4** Cover page priority: Radio buttons for 'No cover page', 'General', 'Urgent!' (selected), and 'Confidential!'.
- 5** Cover page message: Text area containing 'This is an Urgent fax!'.
- 6** Attach up to three documents for faxing: A red button with a document icon.
- 7** Send Fax Now!: A blue button.
- Close: An orange button.

- 1. Recipient's name:** Enter recipient's name.
- 2. Fax Subject:** Enter fax subject.
- 3. Fax Number:** Enter the desired fax number, then click **Add**
 - Up to 10 destinations may be added.
- 4. Cover Page:** Set cover page priority.
- 5. Cover page message:** Add additional text to the cover page.
- 6. Attach Documents:** Click the **Attach up to three documents for faxing**, then select the files to be faxed
- 7. Click Send Fax Now!** to send the fax.

Fax Activity Report

Various detailed status and history reports are available.

From the Main menu select the **Fax Activity Report**  option.

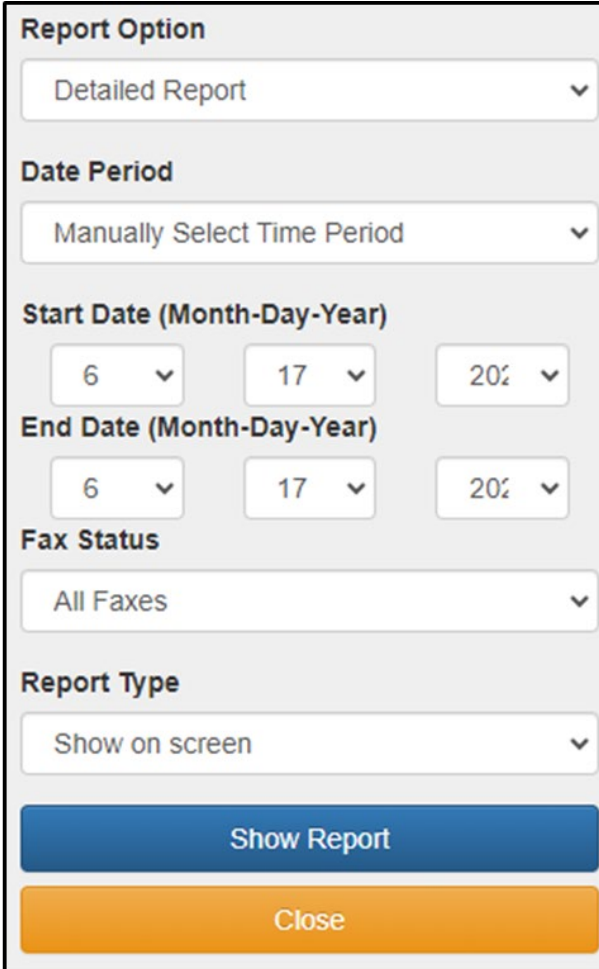

The screenshot shows a configuration form for the Fax Activity Report. It includes the following sections and elements:

- 1 Report Option:** A dropdown menu currently set to "Detailed Report".
- 2 Date Period:** A dropdown menu currently set to "Manually Select Time Period".
- 3 Start Date (Month-Day-Year):** Three dropdown menus for month (6), day (17), and year (202).
- End Date (Month-Day-Year):** Three dropdown menus for month (6), day (17), and year (202).
- 4 Fax Status:** A dropdown menu currently set to "All Faxes".
- 5 Report Type:** A dropdown menu currently set to "Show on screen".
- 6 Show Report:** A blue button to generate the report.
- Close:** An orange button to close the form.

1. **Report Option:** Select between a full Detailed Report, Summary by Country, Summary by Fax Number, or Summary by User.
2. **Date Period:** Select the Date Period for the report. Manually Select Time Period, Month to Date, Last 30 Days, Last Hour, and Today
3. Enter **Manual Time Period** for the report.
4. **Fax Status:** Select what Fax Status to show in the report. All Faxes, Successful Faxes Only, Fax to Email Only, Fax to Fax Only, Processing Faxes Only, and Failed Faxes Only
5. **Report Type:** Select what type of report to display or download. Show on screen, Download in EXCEL, Download in EXCEL zipped
6. Click **Show Report** to view or download the report.

Sample Detailed Report

Close Refresh Total Pages: 17 Total Minutes: 10		15 entries per page Search:										
2 Status	3 Download/View/Resend	4 Fax ID - Dest No.	Country	5 CallerID	Fax Machine	Subject	6 Time	Rate	Pages	Dur.	7 Cost	Retry
Processing	93144144	14693315812	USA	8173574381	6/17/2024 2:35:13 AM PST (GMT-8) FROM: 8173574381-TO: 14693315812	Test_Message_1	6/17/2024 4:35:13 AM	0.03	3	00:00:00	0.00	1
Fax to Email	93144189	*8173574381	Fax to Email	8173574381	6/17/2024 2:42:50 AM PST (GMT-8) FROM: 8173574381-TO: 18173574381	0	6/17/2024 4:42:50 AM	0.00	1	00:01:00	0.00	0
SUCCESS	93144188	18173574381	USA	8173574381	6/17/2024 2:42:50 AM PST (GMT-8) FROM: 8173574381-TO: 18173574381	Jason_Test	6/17/2024 4:42:50 AM	0.03	1	00:01:00	0.03	0
SUCCESS	93144300	14693315812	USA	8173574381	06/17/2024 04:59 FROM: 8173574381-TO: Ryan Smalls@14693315812	Test for Ryan	6/17/2024 4:59:11 AM	0.03	3	00:01:54	0.06	1

1. Click the **Refresh** button to refresh the current report.
2. **Status:** Show current incoming and outgoing fax status and fax type.
3. **Download/View/Resend:** Allows you to Download, View, and Resend faxes
4. **Dest No.:** Destination number of Sent and Received faxes
5. **Caller ID:** Caller ID of Sent and Received faxes
6. **Time:** The time the fax was processed
7. **Cost:** Total cost of the fax.

Note that faxes are stored in the portal for 7 days.

FAQ

ESI eFax

Question	Answer
The Print-to-Fax application says I'm not authorized?	There may be an issue with the login information you are using. Please see your office administrator.
What is the maximum allowable size for the fax file?	3 files @ 4.8 Megabytes each
What is the maximum allowable number of pages that can be faxed?	PC to FAX (Print to Fax): 100 pages FAX to FAX (ATA): No Limit Web to FAX (user portal): 3 files @ 5 Megabytes each Email to FAX (#####@ipfax.net): Limited by email server
How do I create a custom cover page?	See Send a Fax section on how to create fax cover pages.
Can multiple people be added to receive email faxes?	Yes, Multiple email destinations may be added.
How many users can receive inbound faxes to their email?	up to 250 characters of emails addresses
How do I find older faxes?	Please see your office administrator.
How secure is internet fax?	All data is TLS encrypted and cannot be read if intercepted by anyone outside of the recipient.
Is ESI eFax HIPAA compliant?	Yes, all faxes are only viewed by HIPPA sites and those covered under HIPAA through contract.
What do the lights on the ATA (ie: Analog Telephone Adapter) mean?	POWER - Is the ATA powered WAN - It is reaching the local network equipment ONLINE - Is the ATA able to reach the internet FAX - It is processing a fax (this will be off most of the time)
How do I find the IP address of the ATA?	Hook up an analog phone to the ATA and dial *2*#

ESI eFax via eConsole

Question	Answer
What is the maximum allowable size for the fax file?	No Limit
What is the maximum allowable number of pages that can be faxed?	Unlimited
How do I create a custom cover page?	See Send a Fax section on how to create fax cover pages.
Can multiple people be added to receive email faxes?	No, but the Primary user fax account email address can be set to a distribution mailbox to distribute to other recipients.
How many users can receive inbound fax emails?	Only one user per fax account (primary user).
How do I find older faxes?	Go to your fax inbox of the Primary user's eConsole portal.
How secure is internet fax?	All data is TLS encrypted and cannot be read if intercepted by anyone outside of the recipient.
Is the ESI eFax HIPAA compliant?	Yes, all faxes are only viewed by HIPAA sites and those covered under HIPAA through contract.
What do the lights on the ATA (ie: Analog Telephone Adapter) mean?	<p>No Lights: Light Make sure power is connected</p> <p>Red Status: If the Status light remains solid red for longer than 5 minutes, contact your provider.</p> <p>Flashing Green Lights: If multiple green lights are flashing on the Fax ATA, it is downloading a firmware update or getting its provisioning settings. DO NOT remove or disconnect power from the device at this time.</p> <p>WAN Status and Power lights are all green / 3 green lights: Normal Idle Status.</p> <p>Multiple Red Lights / Mixed Green / Red Lights: The Fax ATA is rebooting. This typically takes about 60 seconds before going back to solid green.</p>
How do I find the IP address of the ATA?	Find your device IP Address in your DHCP Server.

Dialing and Sending Faxes

What you hear	What it means and what to do
911 Dialing	The Fax ATA (ie: Analog Telephone Adapter) may not support E-911 dialing. Attempting to dial 911, if not enabled by your provider, will only produce dead air.
Error reported from fax machine	The Fax Machine is unable to connect or communicate with the Fax ATA. Check phone line connection and state of Fax ATA. Please gather fax machine model and error message.
No Dial Tone	The Fax ATA is rebooting or not powered on. This can also be caused if Line 1 or Line 2 is not activated or does not have a phone number attached to it. The Fax ATA provides dial tone for faxing. It should always give you fax tone when dialing out.
Fast Busy	The Fax ATA does not have network or internet access. Check this entering *2* # from a phone or fax machine handset. An audible IP address should be played back to you. Additionally, connect a notebook's Ethernet port to the LAN port on the Fax ATA and verify that the notebook is getting an IP address, network and Internet access. Advanced: You can also log into the Fax ATA's web interface to look at the network settings. See the Fax ATA's user guide supplied with the Fax ATA.
Dead Air	There can be a delay after dialing before you hear fax tone. If you hear silence or "dead air", your dialed number might be blocked. If you dialed 911 and your provider has not enabled support for E-911, you will hear a long period of silence or "dead air" after dialing.

Receiving Faxes

What you hear	What it means and what to do
Symptom	What to Check
Inbound faxes fail to be received	Check that your Fax Machine is powered on and is set to auto answer. Also make sure it is not out paper. If all looks normal please contact your provider. Please have make and model of the fax machine available.
Fax Machine rings but never answers	We have seen some fax machines not accept calls from the ATA (ie: Analog Telephone Adapter). To determine if this is the cause. Please try another fax machine attached to the ATA. If this resolves the issue you should contact the fax machine's manufacturer.